

EP27, EP29 MOVING-IRON VOLTMETERS with a change-over switch



Category of climate versions

If it is not stipulated in another way, these meters are destined to be applied in closed rooms, without air conditioning systems and in conditions of a moderate climate, acc. EN 60051 standard. On customers' request, these meters can be adapted to be applied in dry or wet tropical climate conditions, and also in closed rooms without air conditioning. Then, they are marked with the TIII symbol.

APPLICATION

The EP27 and EP29 moving-iron panel voltmeter with a change-over switch is adapted for measuring line-to-line and phase-to-phase RMS voltages in 3-phase 4-wire power networks.

A six-positional switch installed on the meter frontal side enables the choice of the measured voltage in six different points of the network system.

TECHNICAL DATA

Frontal frame:

- EP27 72 × 72 × 64 mm
- EP29 96 × 96 × 64 mm

Accuracy class

1.5

Measuring range:

- for direct interfacial connection (at the position of the switch on L1-N, L2-N or L3-N) 500 V max. 300 V
- through a voltage transformer $\times/110$ V or $\times/100$ V

Working position

given on the meter $\pm 5^\circ$

Panel material

any

Additional errors within the limits of rated operating conditions

acc. to EN 60051-2

Power consumption

- EP27 max. 4.5 VA ($U_N = 500$ V)
- EP29 max. 4.5 VA ($U_N = 500$ V)

Protection degree

- ensured by the housing acc. to EN 60529
- from terminal side IP40
- from terminal side IP20 (with terminal cover)

Electromagnetic compatibility:

- immunity EN 61000-6-2
- emission EN 61000-6-4

Safety requirements

- installation category EN 61010-1
- pollution level EN 61010-1/A2
- maximal working voltage III
- in relation to the earth 2
- 300 V

Accessories

- screw holders to fix the meter on the panel 2 pcs.

OVERALL DIMENSIONS

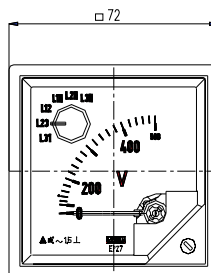

EP27

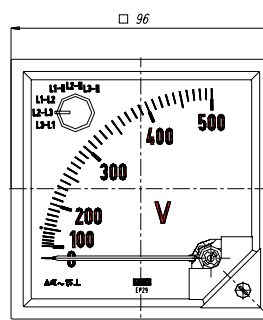
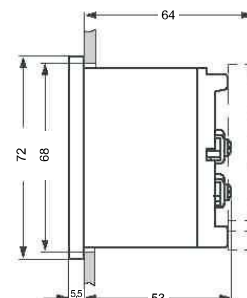

EP29

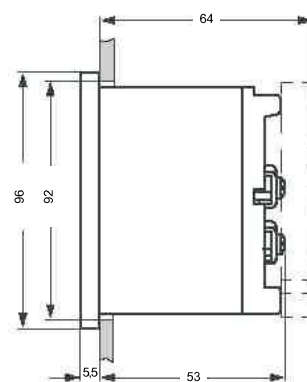

CODES AND AVAILABLE WORKING POSITIONS

Table 1

Code	Working position
0	c3
A	c1
B	c2, $\alpha = 15^\circ$
C	c2, $\alpha = 30^\circ$
D	c2, $\alpha = 45^\circ$
E	c2, $\alpha = 60^\circ$
F	c2, $\alpha = 75^\circ$
H	c4, $\alpha = 105^\circ$
I	c4, $\alpha = 120^\circ$

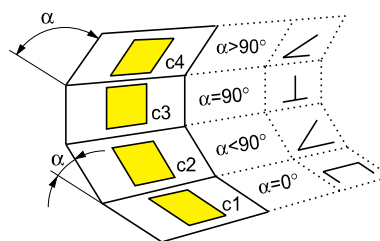

FIXING THE METER IN THE PANEL

Panel cut-out for EP27: $68^{+0.7} \times 68^{+0.7}$ mm
Panel cut-out for EP29: $92^{+0.8} \times 92^{+0.8}$ mm

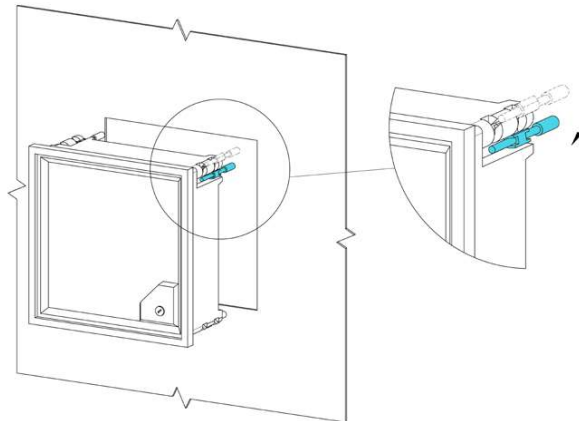
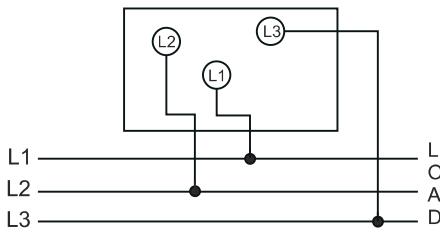
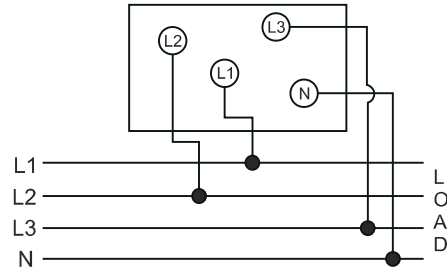

Fig. 1. Fixing the meter EP27 and EP29 in the panel.

CONNECTION DIAGRAM OF EXTERNAL CIRCUITS



Voltage measurement in 3-phase 3-wire network



Voltage measurement in 3-phase 4-wire network

ORDERING CODE

EP27 and EP29 -	X	XXXX	X	XX	X
Climatic version:					
normal	N				
similar to amrine	M				
tropical	T				
Ranges:					
write the range code from the table 2		XXXX			
Operating position:					
acc. to table 1			X		
Version:					
standard				00	
custom-made ¹⁾				XX	
Acceptance tests:					
without a quality inspection certificate					0
with an extra quality inspection certificate					1
according to customer's request					2

¹⁾ after agreeing with the manufacturer

Ordering example:

The code **EP27NC700C000** - means the meter of EP27 type: measuring range 1kV, for voltage transformer 1000/100V, operating position 30°, without a quality inspection certificate.

Table 2

Measuring range	Transformer	Range code	Transformer	Range code	Transformer	Range code
1 kV	1000/100V	C700				
7.5 kV	7500/100V	C701	6000/100V	C742		
10 kV	6000/100V	C702	6000/57.7V	C752	10 000/100V	E703
					10 000/110V	E803
15 kV	10 000/100V	C703	15 000/100V	E704	15 000/110V	E804
17.5kV	15 000/100V	C704				
40 kV	30 000/100V	E707	35 000/100V	C707	30 000/110V	E807
50 kV	50 000/100V	C708				
2.5 kV	2500/100V	C718				
25 kV	25 000/100V	C720	22 000/100V	C722	20000/57.7V	C756
18 kV	15 000/100V	C721				
132 kV	110000/100V	C723				
150 kV	100000/100V	C724	150 000/100V	E709	150 000/110V	E809
			110 000/100V	E723	110 000/110V	E823
110 kV	110000/100V	C725				
8 kV	6300/100V	C733	6000/100V	E721	6000/110V	E821
250 kV	220000/100V	C734	250 000/100V	E710	220 000/100V	E724
			250 000/110V	E810	220 000/110V	E824
450 kV	400 000/100V	C735				
400 kV	300 000/100V	C736	400 000/100V	E711	400 000/110V	E811
7.2 kV	6000/100V	C741				
12 kV	10 000/100V	C743				
100 V		E611				
500 V		E615				
XV	X/100V	E7				
4 kV	3000/100V	E701	3000/110V	E801		
6 kV	6000/100V	E702	6000/110V	E802		
20 kV	20 000/100V	E705	15 000/100V	E722	20 000/110V	E805
					15 000/110V	E822
60 kV	60 000/100V	E708	60 000/110V	E808		
XV	X/110V	E8				

